

EASY REC

SCRAP RECOVERY STANDARD GROUP



rev. 001080.2404.32

■ Easy Rec

- Unit for the correct recovery of the fresh pasta scraps produced at the beginning of production, during shape changeover operations, filled pasta off-cuts, etc.
- Tank capacity: 30 litres
- Indicative operating capacity: 50-150 kg/h approximately

EASY REC

Unit for the correct recovery of the fresh pasta scraps produced at the beginning of production, during shape changeover operations, filled pasta off-cuts, etc. Allows the user to obtain pasta scraps which can easily be re-kneaded with excellent results.

Main technical features:

- Tank capacity: 30 litres
- Indicative operating capacity: 50-150 Kg/h approximately
- It is suitable for small/medium lumps
- Inexpensive: the best quality/price ratio



Easy rec



Uniformly ground product



■ Easy Rec



■ Uniformly ground product

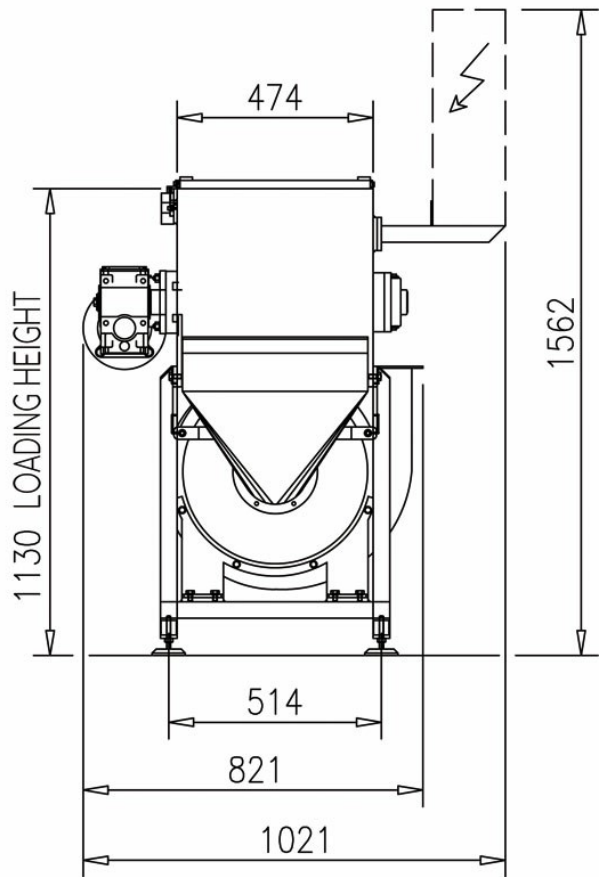
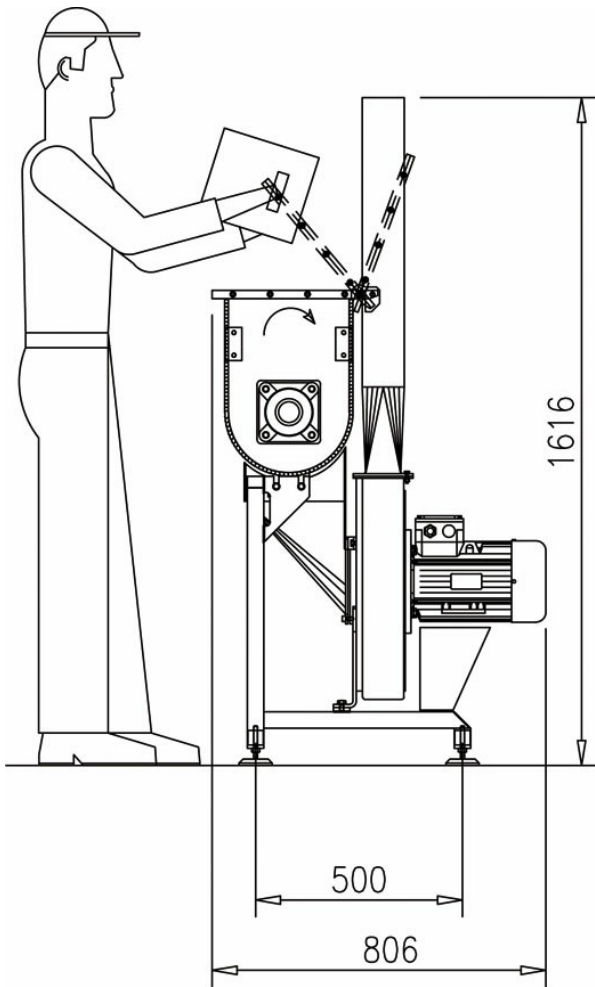

MODEL	POWER (kW)	PIPING LENGHT (m)	MAXIMUM SHREDDING CAPACITY (kg/h)	DIMENSIONS (LxPxH)
EASY REC 150	4.5*	15	50-150	1021X806X1616

*(3kW each fan-shredder)

NotaBene: data shown are not binding, just indicative as subject to variability of the products and plants where the groups will be installed.



facebook.com/storci.spa



youtube.com/user/StorciPastaMachinery



linkedin.com/company/storci-spa

Storci S.p.A.
via Lemignano, 6 - 43044 Collecchio (Parma)
phone: +39 0521 543611 fax: +39 0521 543621
www.storci.com - sales-storci@storci.com

